

Tenso P-14

Pat. pend.

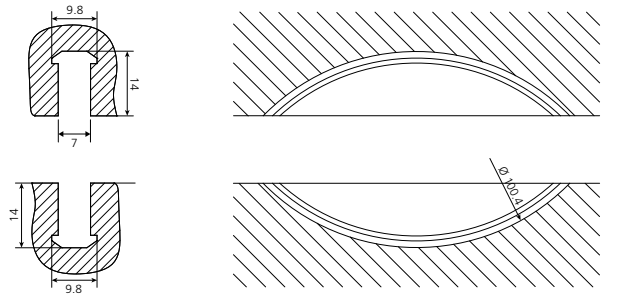
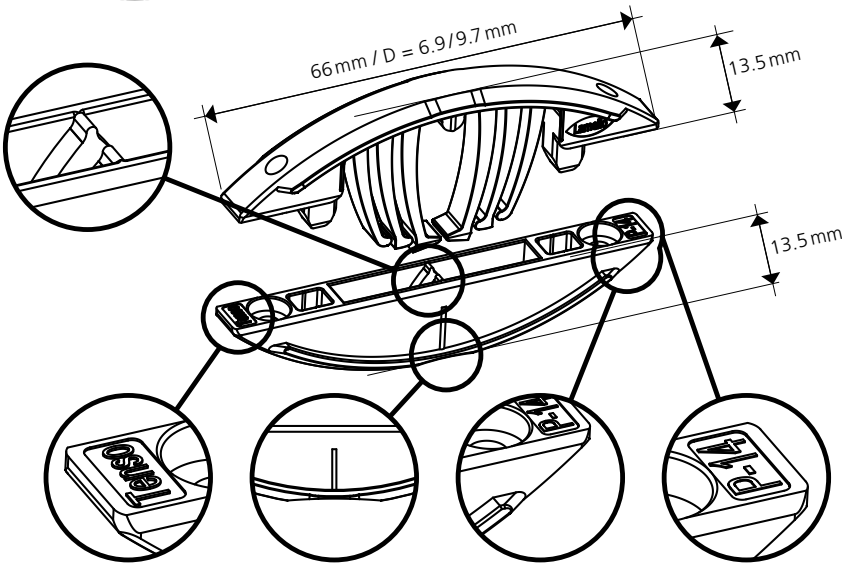

Anzugskraft / Tensile Force: 150 N

Haltekraft / Retention Force: 250 N

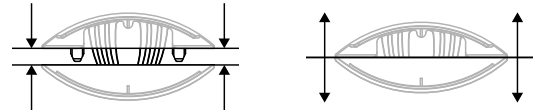

Immer in Verbindung mit Klebstoff verwenden

zusätzlicher Klebstoff im Verbinder erhöht die Zugbruchfestigkeit um 30%

Hinweis: Trockener Zusammenbau mit **Bisco P-14** möglich

Always use in combination with glue

additional glue in the fitting increases the tensile strength by 30%

Tip: Test assembly with **Bisco P-14** possible

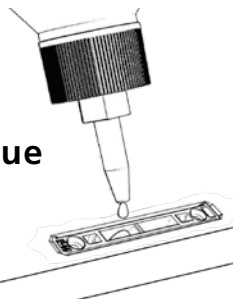

Wichtig: Für eine maximale Spannkraft!
Important: For maximum clamping force!

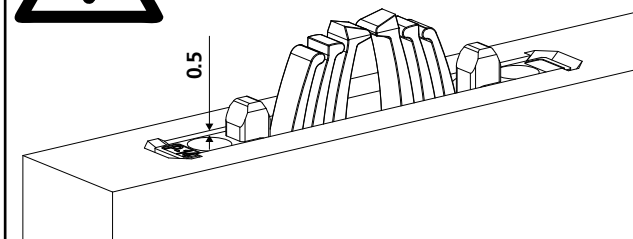

Zeta P2

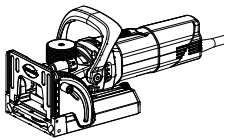

Art.No. 101402



Art.No. 132140 (Diamant)
DP, Ø 100.4 x 7 x 22 mm



Art.No. 132141
HW, Ø 100.9 x 7 x 22 mm

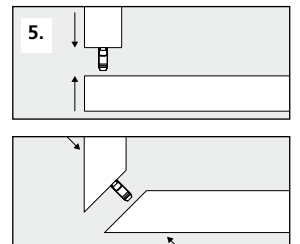
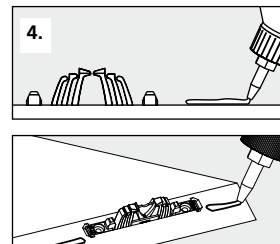
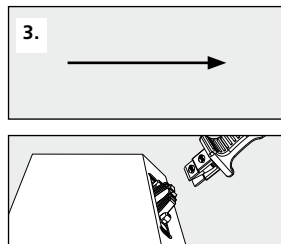
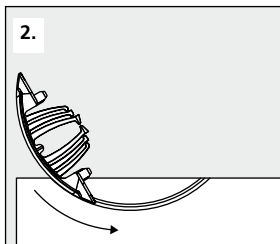
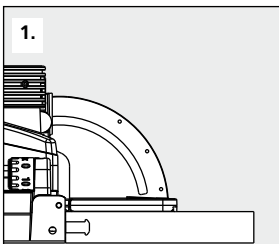
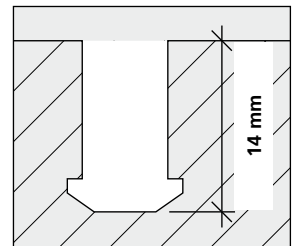
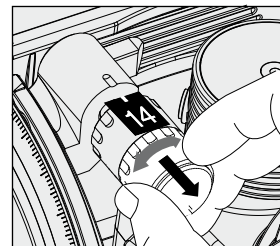

max. 30 min

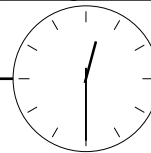

Anwendungen / Applications

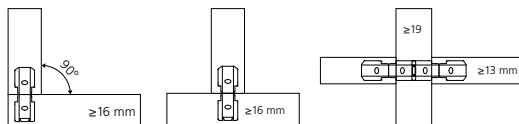

P-10

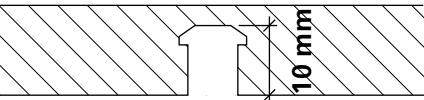

P-18

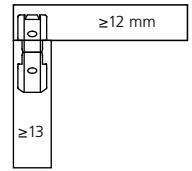
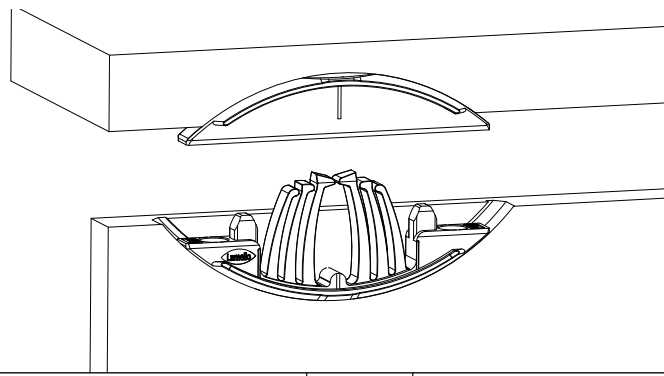
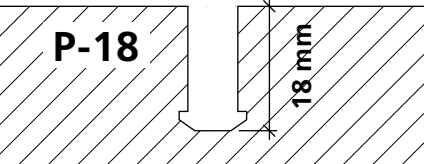

P-18

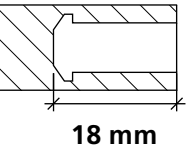

P-10

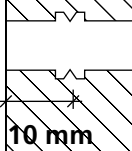

P-18

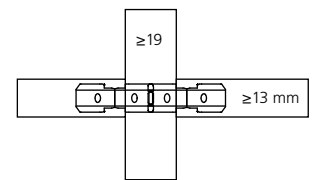
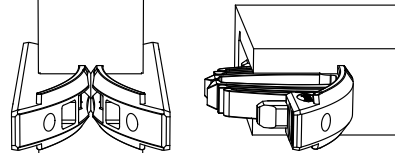
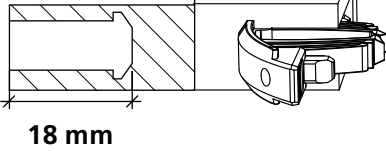

CNC | Partner network: www.lamello.com

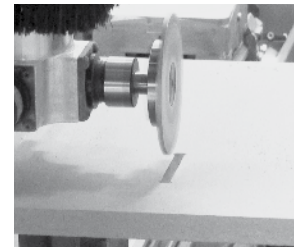
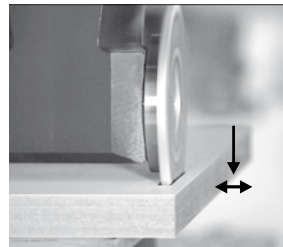
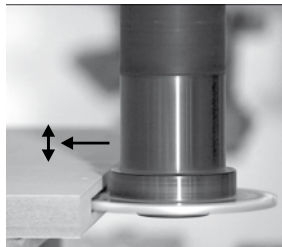
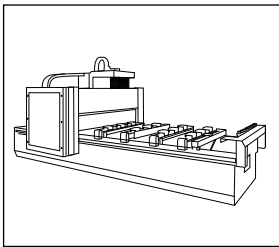

Art. No. 132142

DP, 100.4 × 7 × 30 mm
4 / 6.6 / DTK 48 mm

* Passend zu allen aufgeführten Fräsdornen
Suitable for all cutter arbors listed

Art. No. 132143

DP, 100.4 × 7 × 40 mm
4 / 5.5 / DTK 52 mm

Art. No. 132144

DP, 100.4 × 7 × 16 mm
4 / 5.5 / DTK 28 mm



*** Art. No. 132150**

20 × 50, L = 102 mm

*** Art. No. 132151**

25 × 60, L = 102 mm

*** Art. No. 132152**

16 × 50, L = 85 mm

*** Art. No. 132153**

16 × 55, L = 68 mm

*** Art. No. 132154**

16 × 50, L = 85 mm, mit Spannfläche (2°-schräg) / with clamping surface (2°-angle)

*** Art. No. 132155**

20 × 50, L = 85 mm, mit Spannfläche (2°-schräg) / with clamping surface (2°-angle)



Starter-Set: Tensio P-14 + Vorspann-clip / preload clip



Paar/Pair/ Paire/Paio	Art. No.
80	145415S
300	145425S

**Vorspann-Clip/
preload clip**



Stück/Piece/ Pièce/Pezzi	Art. No.
300	145426
1000	145436

Divario P-18



Paar/Pair/ Paire/Paio	Art. No.
80	145550
300	145560
1000	145570

Tensio P-14

mit Vorspann-Funktion /
with preload function



Paar/Pair/ Paire/Paio	Art. No.
80	145415
300	145425
1000	145435

**Clamex P Medius
14/10**



Paar/Pair/ Paire/Paio	Art. No.
80	145370
300	145371
1000	145357

Clamex P-14



Paar/Pair/ Paire/Paio	Art. No.
80	145334
300	145346
1000	145356

Clamex P-10



Paar/Pair/ Paire/Paio	Art. No.
80	145372
300	145373
1000	145374

**Bisco P-14
Bisco P-10**



Stück/piece/ pièce/pezzi	Art. No.
P-10 80	145304
300	145305
P-14 80	145301
300	145302
1000	145303