

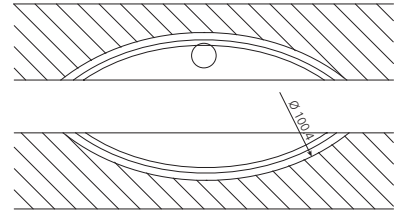

Clamex P-10

Pat. pend.

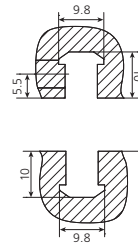
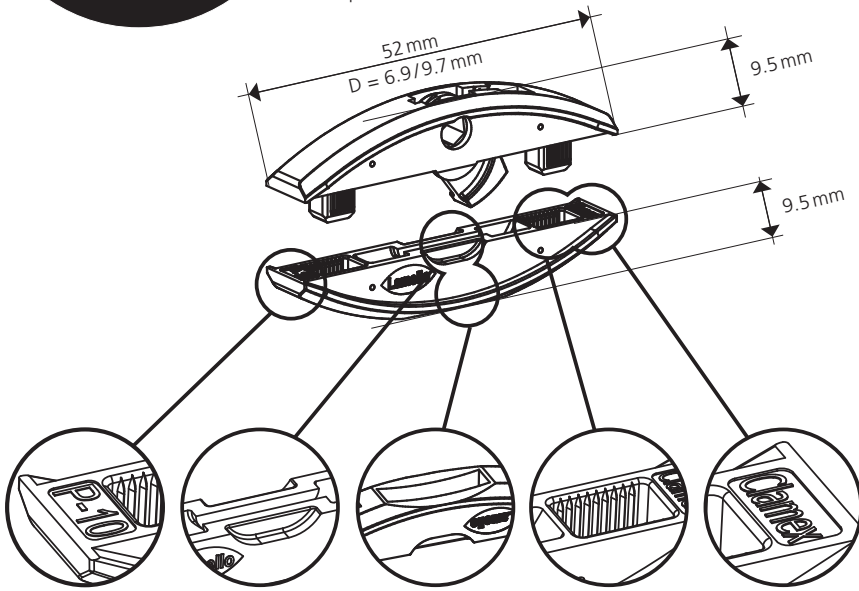

Zugbruchfestigkeit / Tensile strength:

Spanplatte / particle board:

~ 600 N = 60 kg

Buche massiv / beech massive:

~ 900 N = 90 kg

MDF:

~ 600 N = 60 kg

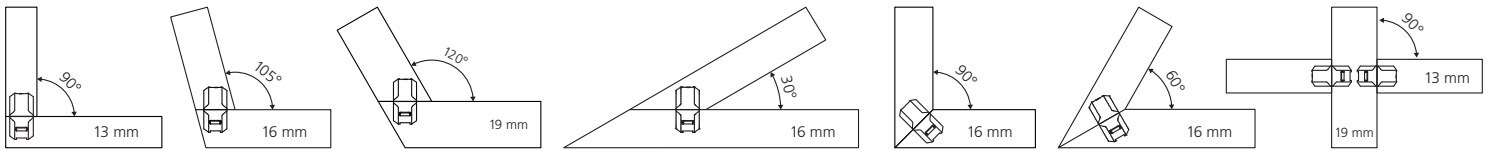
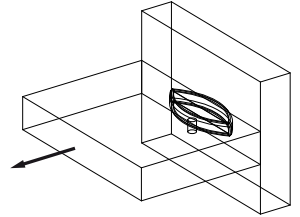

P-10

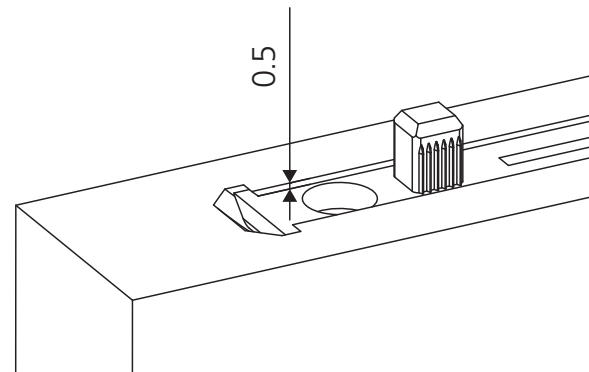
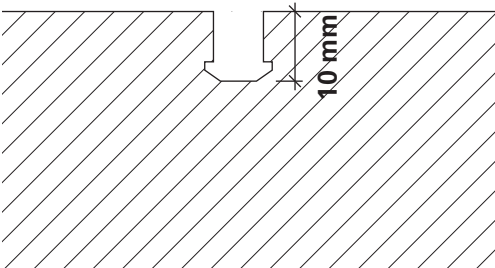

Scharfe Fräser verwenden
Use sharp cutters

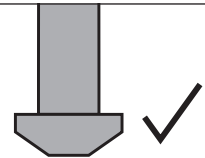

Divario P-18



Paar/Pair/ Paire/Paio	Art. No.
80	145550
300	145560
1000	145570

Tenso P-14 mit Vorspann-Funktion



Paar/Pair/ Paire/Paio	Art. No.
80	145415
300	145425
1000	145435

Clamex P Medium 14/10



Paar/Pair/ Paire/Paio	Art. No.
80	145370
300	145371

Clamex P-14



Paar/Pair/ Paire/Paio	Art. No.
80	145334
300	145346
1000	145356

Clamex P-10



Paar/Pair/ Paire/Paio	Art. No.
80	145372
300	145373
1000	145374

Bisco P-14 Bisco P-10



Stück/Piece/ Pièce/Pezzi	Art. No.
P-10 80	145304
300	145305
P-14 80	145301
300	145302
1000	145303

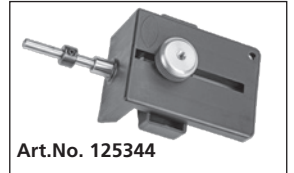
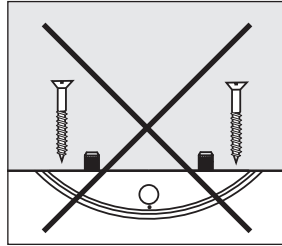
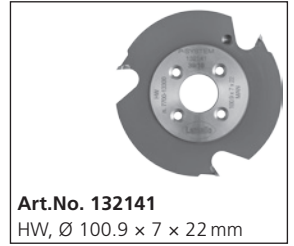
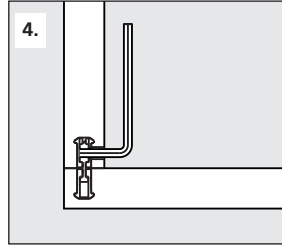
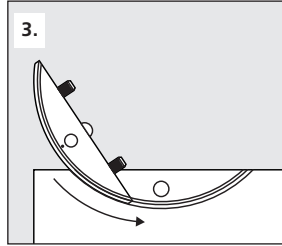
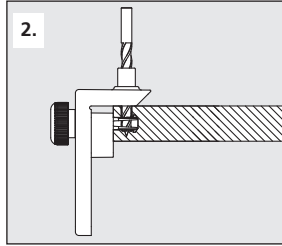
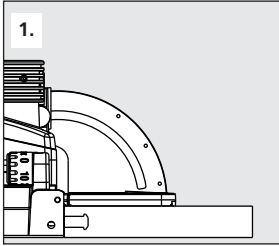
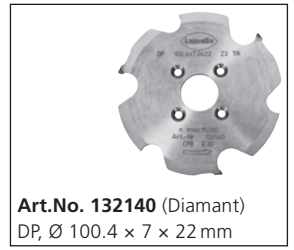
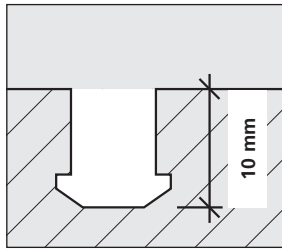
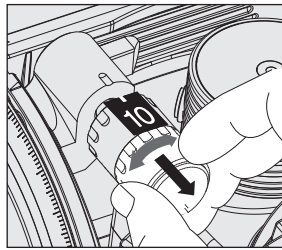
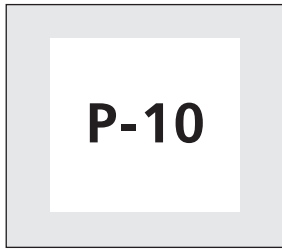
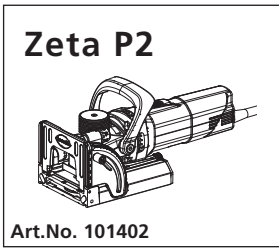

CNC | Partner network: www.lamello.com

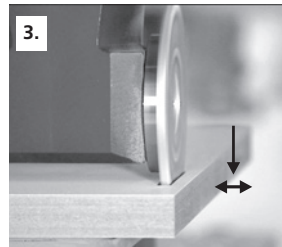
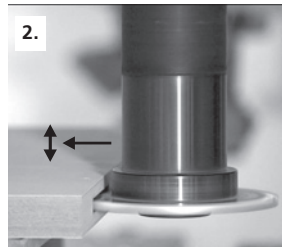
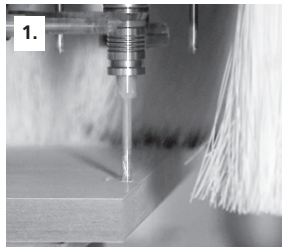
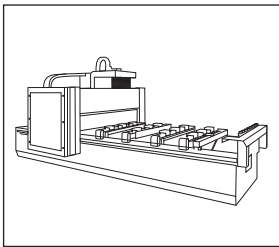

Art. No. 132142
DP, 100.4 × 7 × 30 mm
4 / 6.6 / DTK 48 mm
* Passend zu allen aufgeführten Fräsdornen
Suitable for all cutter arbors listed

Art. No. 132143
DP, 100.4 × 7 × 40 mm
4 / 5.5 / DTK 52 mm

Art. No. 132144
DP, 100.4 × 7 × 16 mm
4 / 5.5 / DTK 28 mm

* **Art. No. 132150**
20 × 50, L = 102 mm

* **Art. No. 132151**
25 × 60, L = 102 mm

* **Art. No. 132152**
16 × 50, L = 85 mm

* **Art. No. 132153**
16 × 55, L = 68 mm

* **Art. No. 132154**
16 × 50, L = 85 mm, mit Spannfläche (2°-schräg) / with clamping surface (2°-angle)

* **Art. No. 132155**
20 × 50, L = 85 mm, mit Spannfläche (2°-schräg) / with clamping surface (2°-angle)

Abdeckkappen / Cover caps
100 Stück / 100 Pieces

90°

RAL	Art. No.
9010	335280
9011	335281
1014	335282
1011	335283
8007	335284
8017	335289
9002	335285
7035	335286
7040	335287
7031	335288

45°

RAL	Art. No.
9010	335380
9011	335381
1014	335382
1011	335383
8017	335384
7022	335388

Art. No. 131556
Ø = 6 / 10 mm
l = 100 / 35 mm

Art. No. 271945
Ø = 4 mm
75 × 55 mm

Art. No. 271945A
Ø = 4 mm
120 × 50 mm

Art. No. 251993
Ø = 4 mm
flexibel

Art. No. 131342
Ø 12 × 40
L = 80 mm

